

CZECH PARTICIPATION AT FACILITY
FOR ANTIPROTON AND ION RESEARCH (FAIR)



Electromagnetic Calorimeter for HADES

Petr Chudoba

Nuclear Physics Institute
of the Czech Academy of Sciences



EUROPEAN UNION
European Structural and Investment Funds
Operational Programme Research,
Development and Education



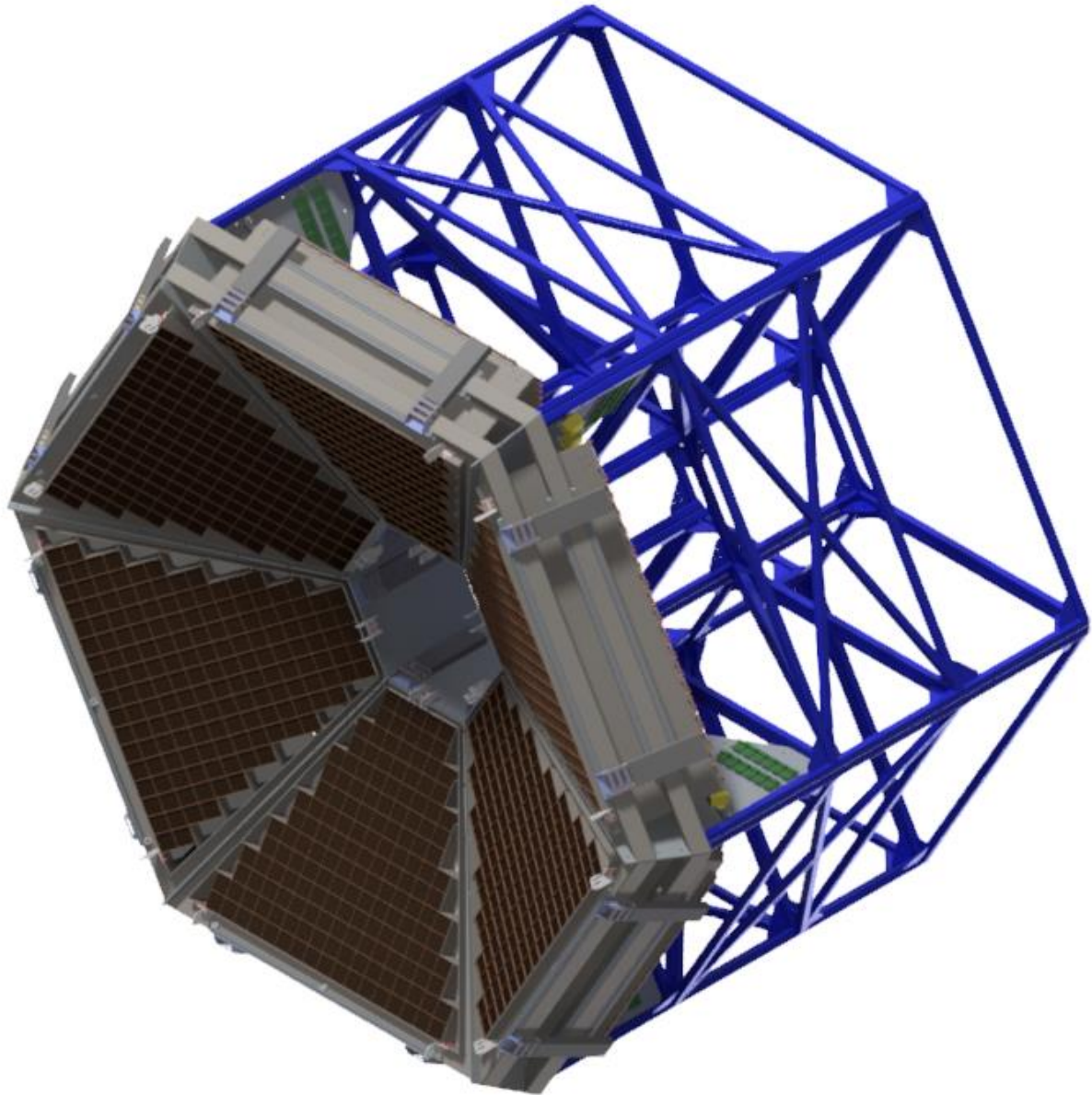

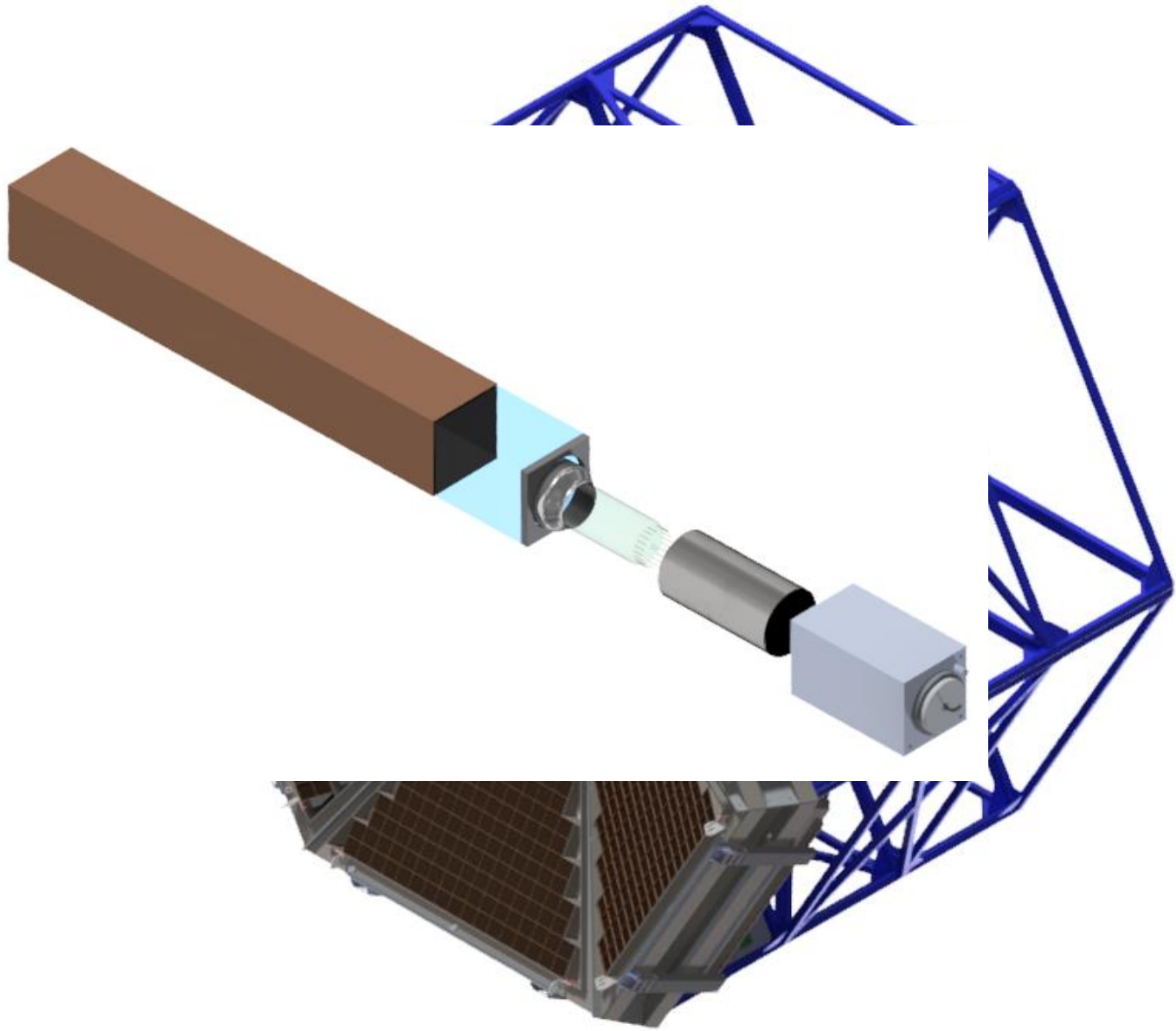

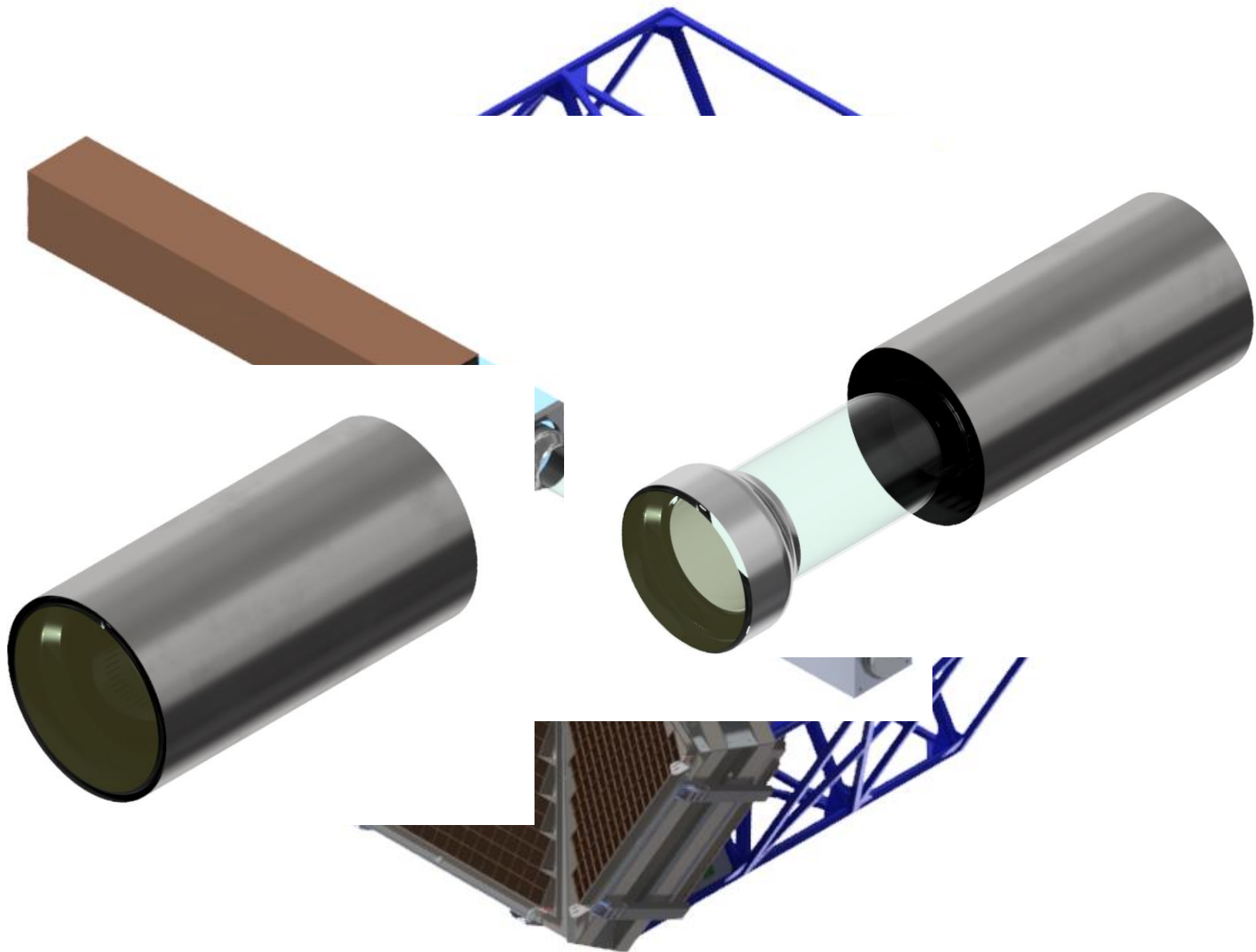

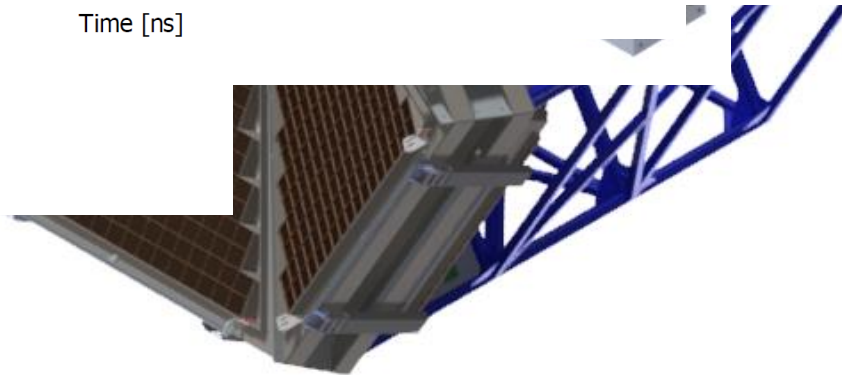
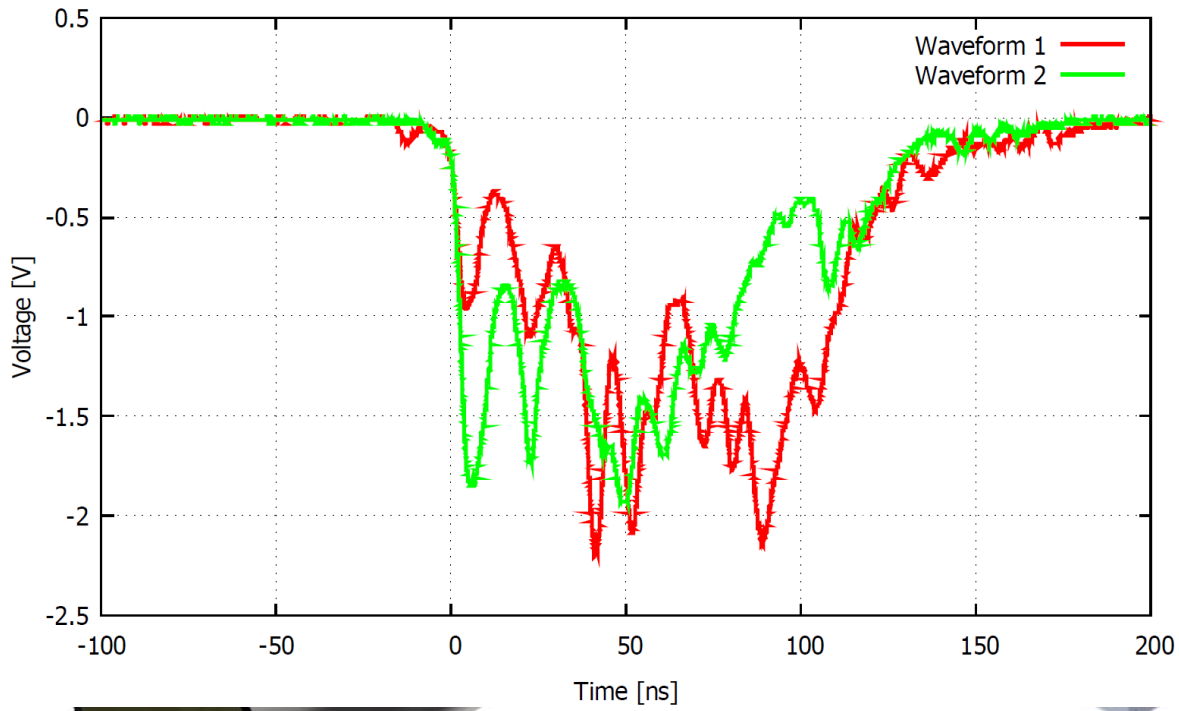

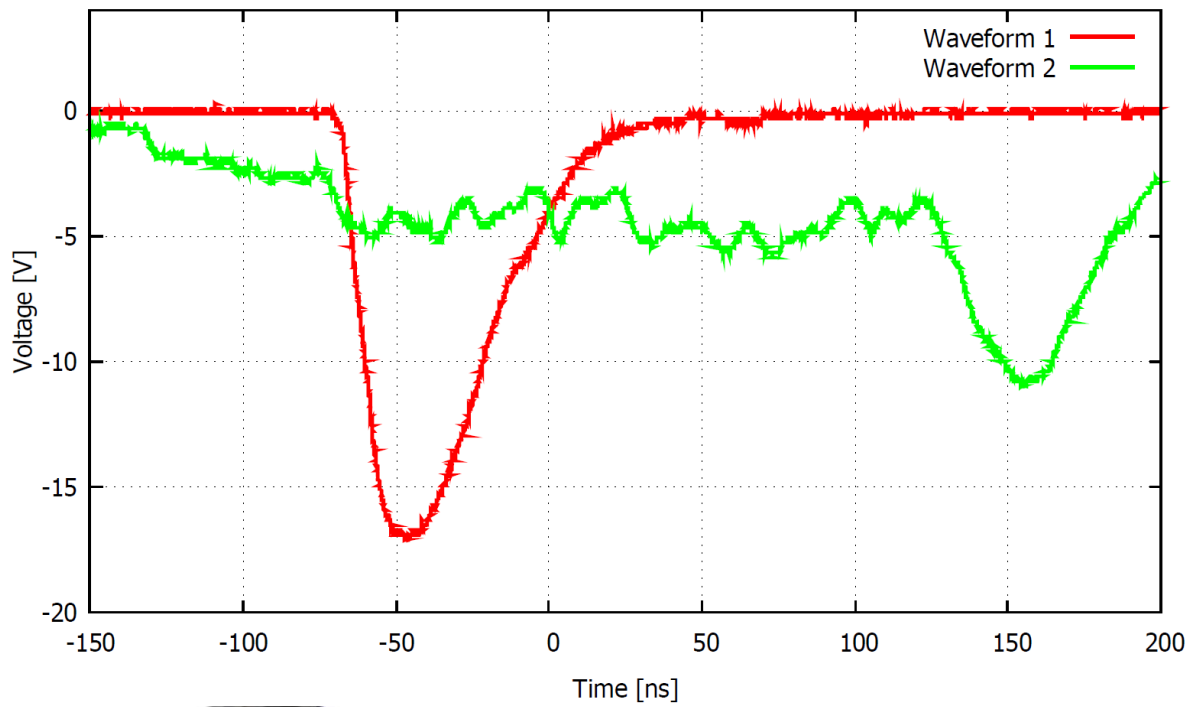
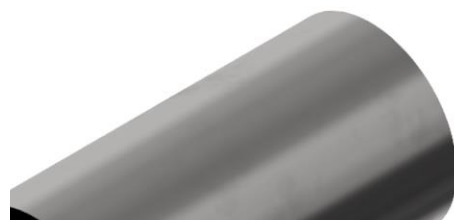
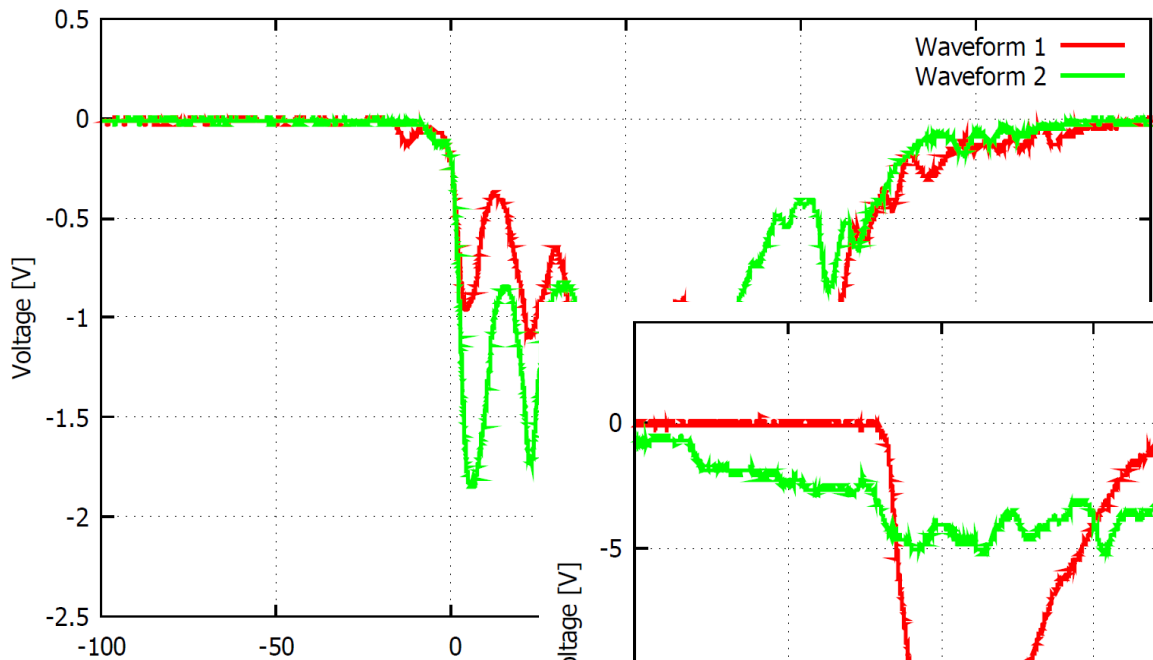

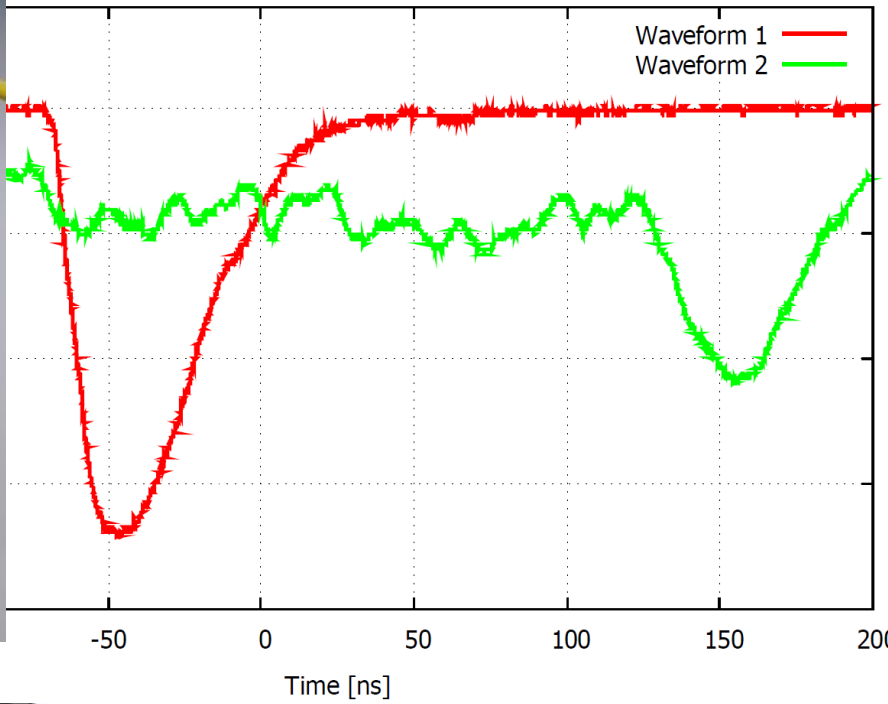
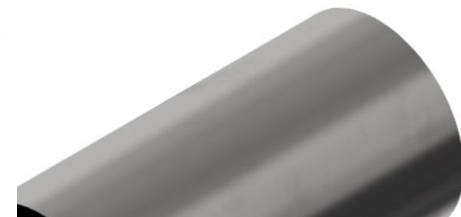
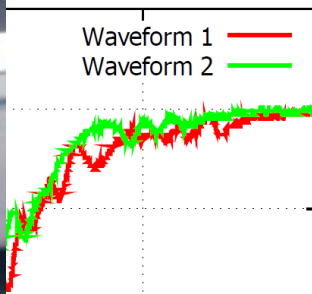
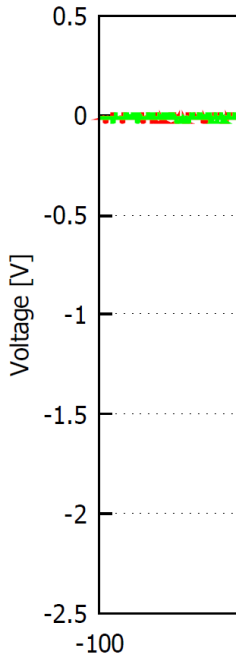

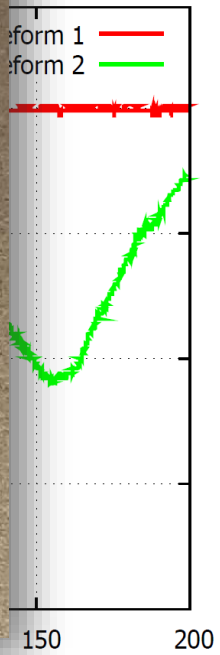
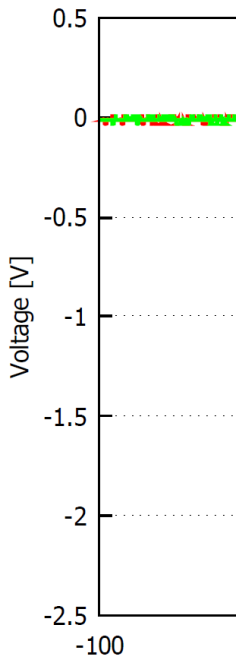

Time [ns]

See you at the poster session



Work supported by:

MEYS CZ - LM2015049 grant

FAIR-CZ-OP grant CZ.02.1.01/0.0/0.0/16_013/0001677

LTT17003

GACR GA13-06759S